



LIFTING GEAR HIRE CORPORATION

PHONE: 800-878-7305 FAX: 708-430-3536

www.lgh-usa.com

**3 TON ADJUSTABLE GANTRY
SPANCO A SERIES**

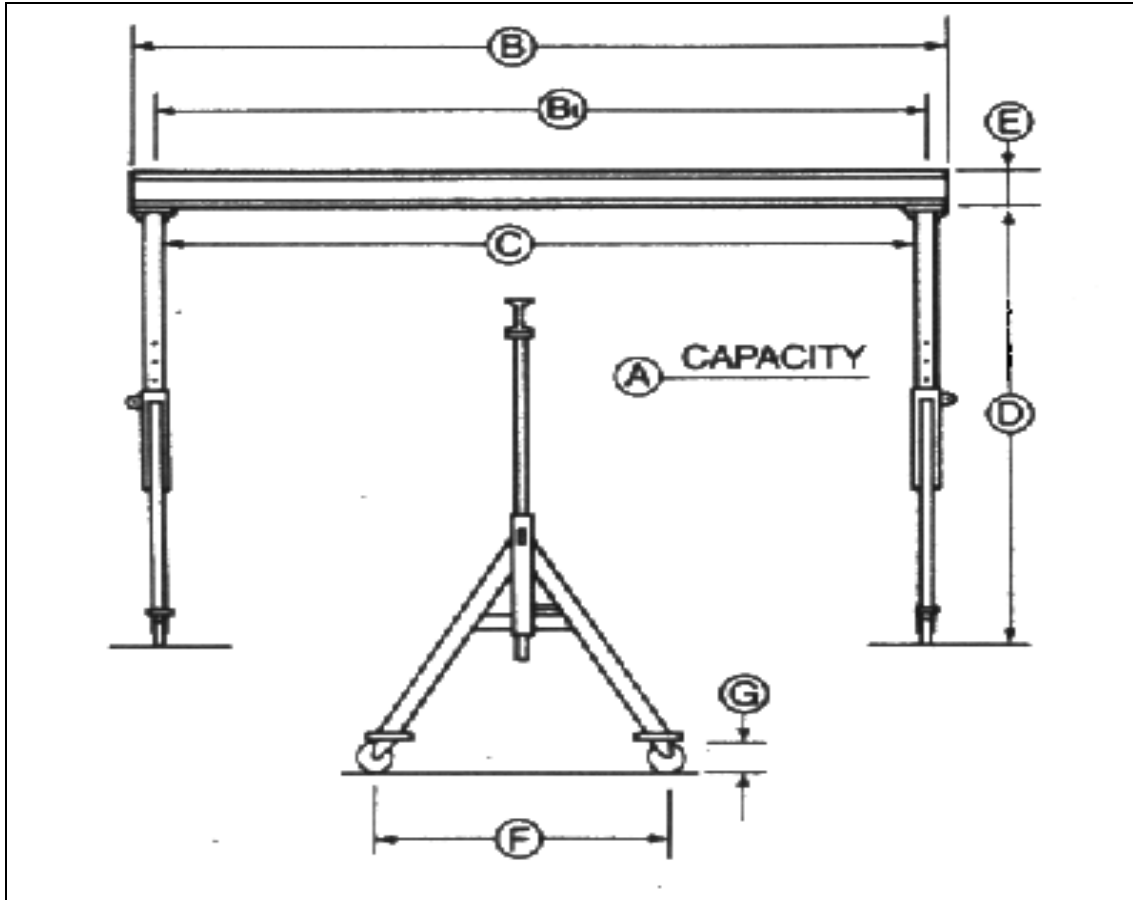

GANTRY DIMENSIONS (in.)

A	B	B1	C	D	E	F	G
3 Ton	10' - 40'	B - 11"	B - 15"	9'4" - 12'10" (or) 12'4" - 15'10"	*	6'6"	8"

GANTRY SPECIFICATIONS

Rated Load (lbs.)	Weight Legs (LBS.)	Height Under The Beam (D) Min / Max
6,000	609 / 673 #	9'4" 12'10" (or) 12'4" 15'10"

* = I-Beam Depth will vary depending on length of beam used