



LIFTING GEAR HIRE CORPORATION

PHONE: 800-878-7305 FAX: 708-430-3536

www.lgh-usa.com

**3 TON BEAM TROLLEY
RILEY SUPERCLAMP B1**

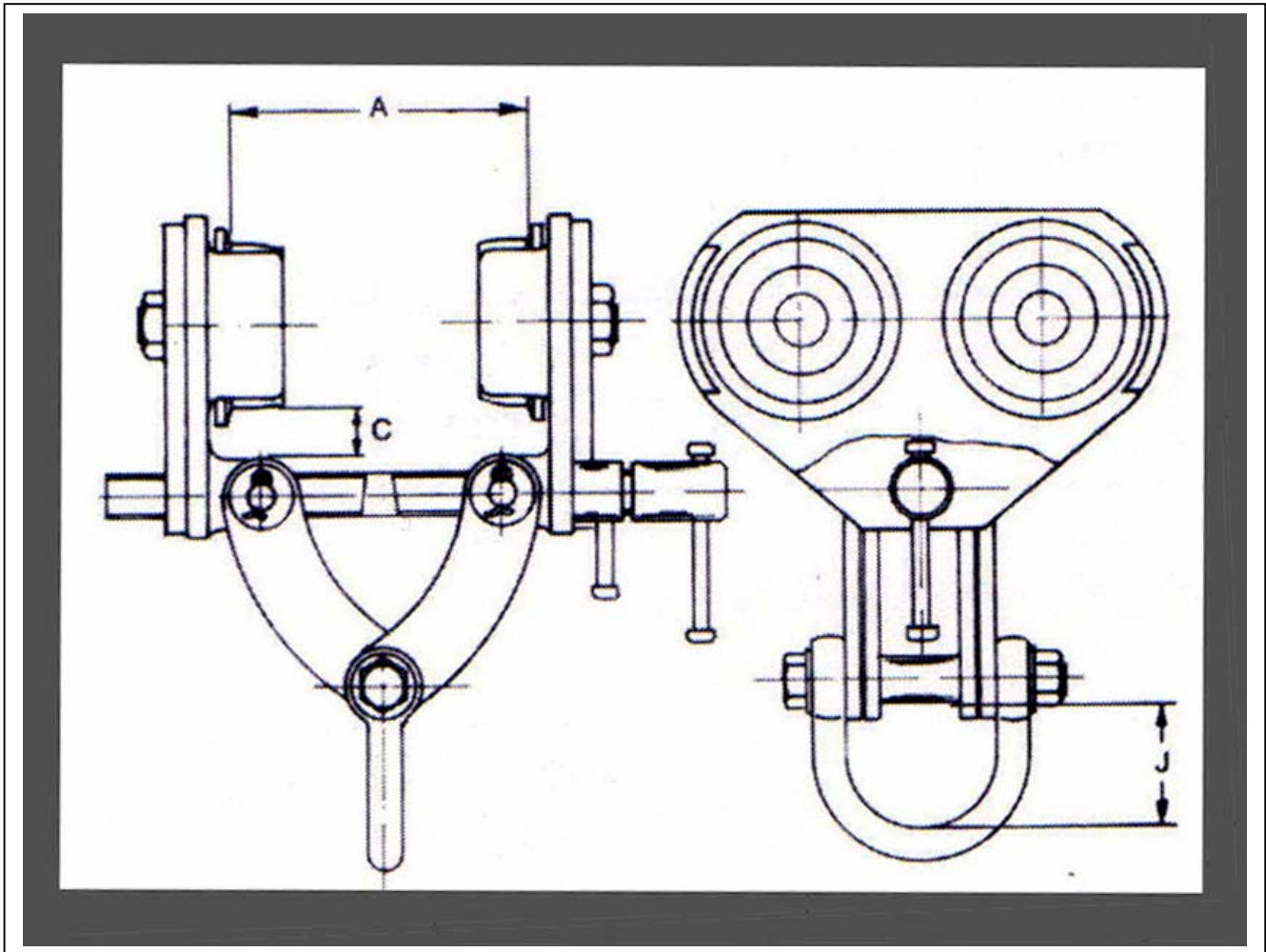

BEAM TROLLEY DIMENSIONS (in.)

<u>A</u>	<u>C</u>	<u>J</u>	<u>Weight</u>	<u>S.W.L.</u>	<u>Flange Size</u>
3" - 8"	1 1/8"	4"	60.6#	6,096 LBS.	3" - 8"