



LIFTING GEAR HIRE CORPORATION

PHONE: 800-878-7305 FAX: 708-430-3536

www.lgh-usa.com

1 TON BEAM TROLLEY

Riggers Model

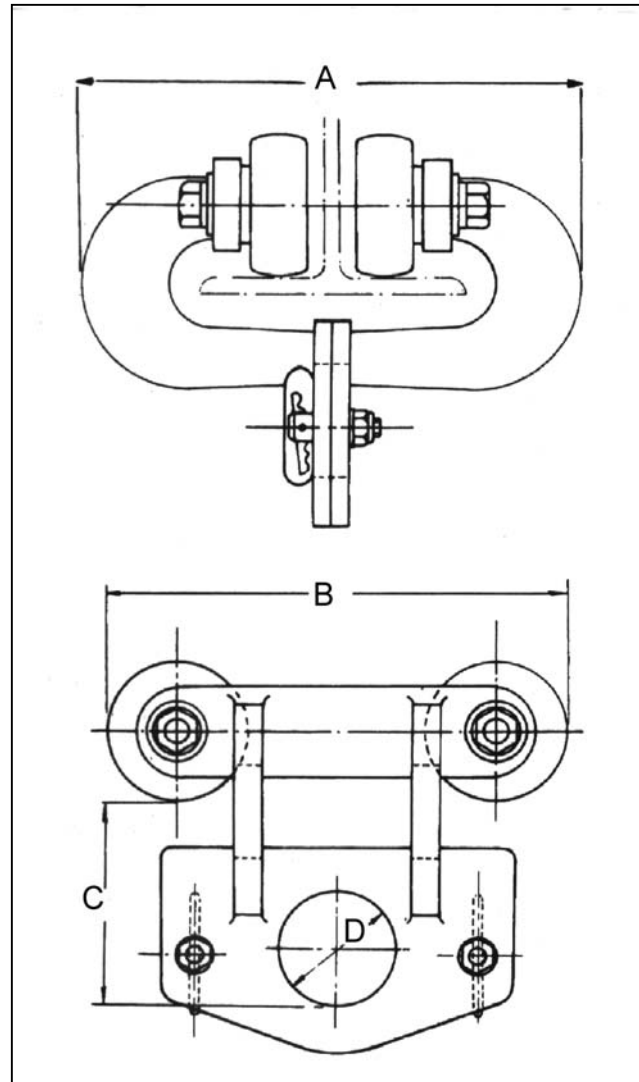

BEAM TROLLEY DIMENSIONS (in.)

A	B	C	Weight	S.W.L.	Flange Size
13.51"	7.99"	3.78"	18#	2,000 LBS.	3" - 8"